

1 Form A Solid State Relay

Features

- Isolation Test Voltage 5300 V_{RMS}
- Current-limit Protection
- High-reliability Monolithic Detector
- Low Power Consumption
- Clean, Bounce-free Switching
- High Surge Capability
- Surface Mountable
- Lead-free component
- Component in accordance to RoHS 2002/95/EC and WEEE 2002/96/EC

Agency Approvals

- UL1577, File No. E52744 System Code H or J, Double Protection
- CSA - Certification 093751
- BSI/BABT Cert. No. 7980
- DIN EN 60747-5-2 (VDE0884)
DIN EN 60747-5-5 pending
- FIMKO Approval

Applications

General Telecom Switching
Instrumentation
Industrial Controls

Description

Vishay Solid State Relays (SSRs) are miniature, optically-coupled relays with high-voltage MOSFET outputs. The LH1518 relays are capable of switching AC or DC loads from as little as nanovolts to hundreds of volts.

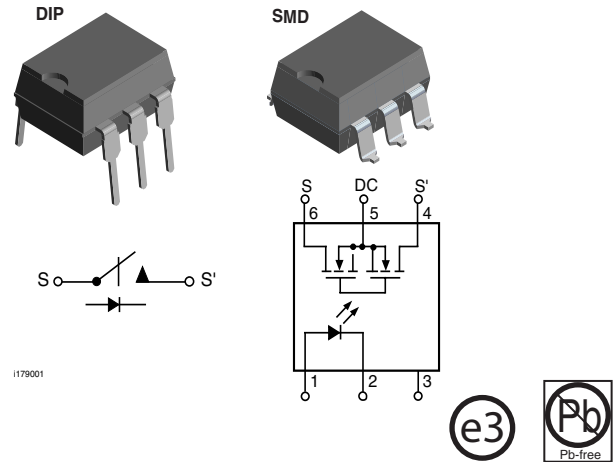

The relays can switch currents in the range of nanoamps to hundreds of milliamps. The MOSFET switches are ideal for small signal switching and are primarily suited for dc or audio frequency applications.

The LH1518 relays feature a monolithic output die that minimizes wire bonds and permits easy integration of high-performance circuits such as current limiting in normally-open switches. The output die integrates the photodiode receptor array, turn-on and turn-off control circuitry, and the MOSFET switches. The optically-coupled input is controlled by a highly efficient GaAlAs infrared LED.

Order Information

Part	Remarks
LH1518AAB	Tubes, SMD-6
LH1518AABTR	Tape and Reel, SMD-6
LH1518AT	Tubes, DIP-6

Absolute Maximum Ratings, $T_{amb} = 25\text{ }^{\circ}\text{C}$

Stresses in excess of the absolute Maximum Ratings can cause permanent damage to the device. Functional operation of the device is not implied at these or any other conditions in excess of those given in the operational sections of this document. Exposure to absolute Maximum Ratings for extended periods of time can adversely affect reliability.

SSR

Parameter	Test condition	Symbol	Value	Unit
LED continuous forward current		I_F	50	mA
LED reverse voltage	$I_R \leq 10\text{ }\mu\text{A}$	V_R	8.0	V
DC or peak AC load voltage		V_L	250	V
Continuous DC load current, bidirectional operation		I_L	155	mA
Continuous DC load current, unidirectional operation		I_L	300	mA
Peak load current (single shot)	$t = 100\text{ ms}$	I_P	1)	
Ambient temperature range		T_{amb}	- 40 to + 85	$^{\circ}\text{C}$
Storage temperature range		T_{stg}	- 40 to + 150	$^{\circ}\text{C}$
Pin soldering temperature	$t = 10\text{ s max}$	T_{sld}	260	$^{\circ}\text{C}$
Input/output isolation voltage		V_{ISO}	5300	V_{RMS}
Output power dissipation (continuous)		P_{diss}	550	mW

1) Refer to Current Limit Performance Application Note 58 for a discussion on relay operation during transient currents.

Electrical Characteristics, $T_{amb} = 25\text{ }^{\circ}\text{C}$

Minimum and maximum values are testing requirements. Typical values are characteristics of the device and are the result of engineering evaluations. Typical values are for information only and are not part of the testing requirements.

Input

Parameter	Test condition	Symbol	Min	Typ.	Max	Unit
LED forward current, switch turn-on	$I_L = 100\text{ mA}$, $t = 10\text{ ms}$	I_{Fon}		0.8	2.0	mA
LED forward current, switch turn-off	$V_L = \pm 200\text{ V}$	I_{Foff}	0.2	0.7		mA
LED forward voltage	$I_F = 10\text{ mA}$	V_F	1.15	1.26	1.45	V

Output

Parameter	Test condition	Symbol	Min	Typ.	Max	Unit
ON-resistance ac/dc: Pin 4(±) to 6 (±)	$I_F = 5.0\text{ mA}$, $I_L = 50\text{ mA}$	R_{ON}	10	15	20	Ω
ON-resistance dc: Pin 4, 6 (+) to 5 (±)	$I_F = 5.0\text{ mA}$, $I_L = 100\text{ mA}$	R_{ON}	2.5	3.75	5.0	Ω
Off-resistance	$I_F = 0\text{ mA}$, $V_L = \pm 100\text{ V}$	R_{OFF}	0.5	5000		$G\Omega$
Current limit ac/dc : Pin 4 (±) to 6 (±)	$I_F = 5.0\text{ mA}$, $V_L = \pm 6.0\text{ V}$, $t = 5.0\text{ ms}$	I_{LMT}	170	200	280	mA
Off-state leakage current	$I_F = 0\text{ mA}$, $V_L = \pm 100\text{ V}$	I_O		0.02	200	nA
	$I_F = 0\text{ mA}$, $V_L = \pm 250\text{ V}$	I_O			1.0	μA
Output capacitance Pin 4 to 6	$I_F = 0\text{ mA}$, $V_L = 1.0\text{ V}$	C_O		55		pF
	$I_F = 0\text{ mA}$, $V_L = 50\text{ V}$	C_O		10		pF
Switch offset	$I_F = 5.0\text{ mA}$	V_{OS}		0.15		V

Transfer

Parameter	Test condition	Symbol	Min	Typ.	Max	Unit
Capacitance (input-output)	$V_{ISO} = 1.0\text{ V}$	C_{IO}		0.8		pF
Turn-on time	$I_F = 5.0\text{ mA}$, $I_L = 50\text{ mA}$	t_{on}		1.4	3.0	ms
Turn-off time	$I_F = 5.0\text{ mA}$, $I_L = 50\text{ mA}$	t_{off}		0.7	3.0	ms

Typical Characteristics ($T_{amb} = 25\text{ }^\circ\text{C}$ unless otherwise specified)

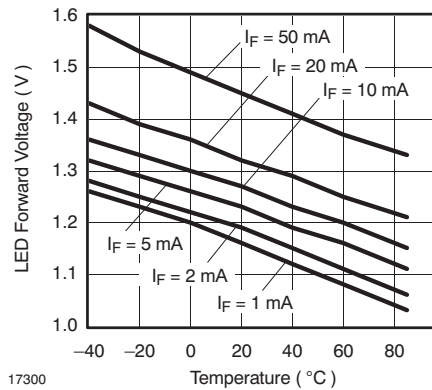

Figure 1. LED Voltage vs. Temperature

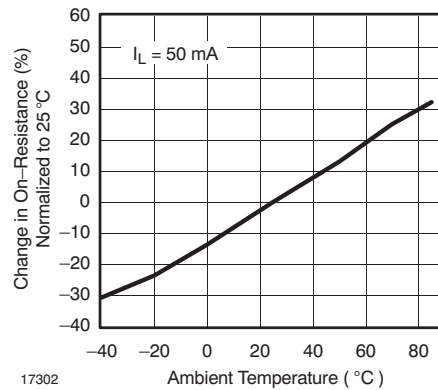

Figure 3. ON-Resistance vs. Temperature

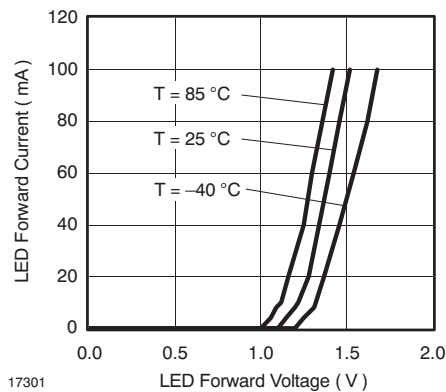

Figure 2. LED Forward Current vs. LED Forward Voltage

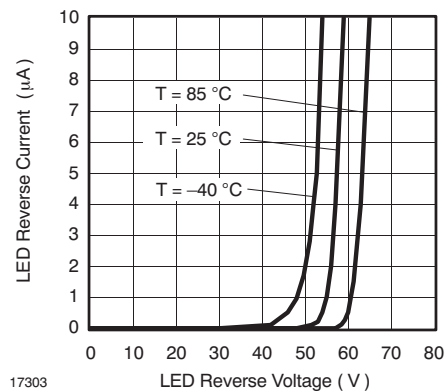

Figure 4. LED Reverse Current vs. LED Reverse Voltage

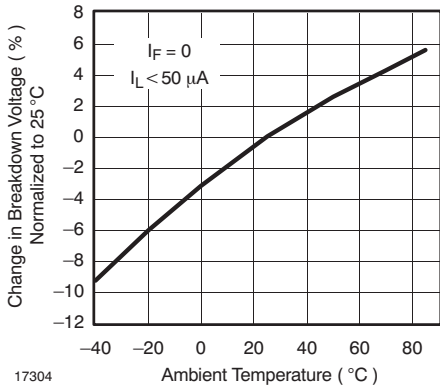

Figure 5. Switch Breakdown Voltage vs. Temperature

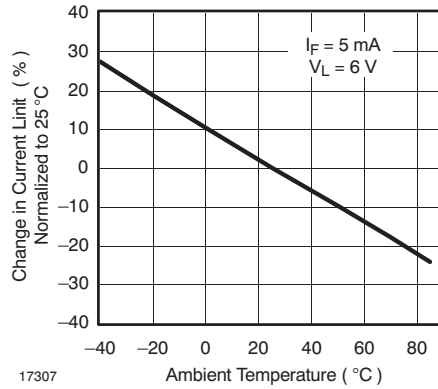

Figure 8. Current Limit vs. Temperature

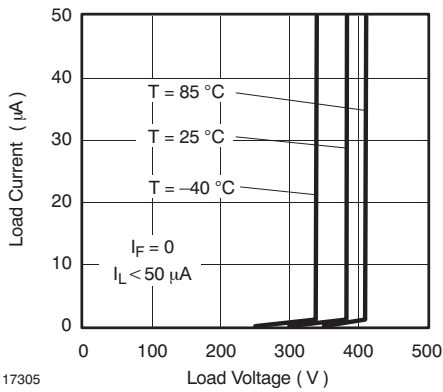

Figure 6. Switch Breakdown Voltage vs. Load Current

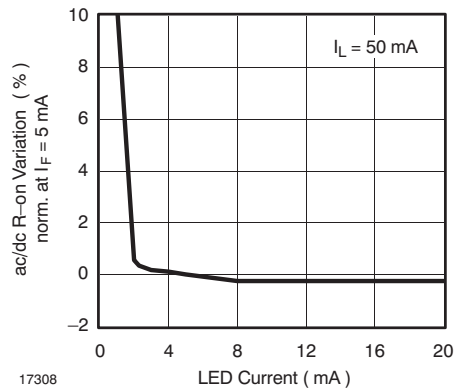

Figure 9. Variation in ON-Resistance vs. LED Current

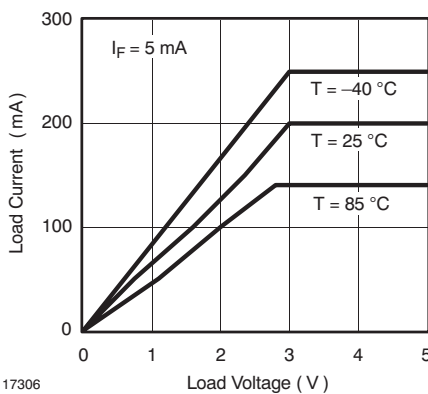

Figure 7. Load Current vs. Load Voltage

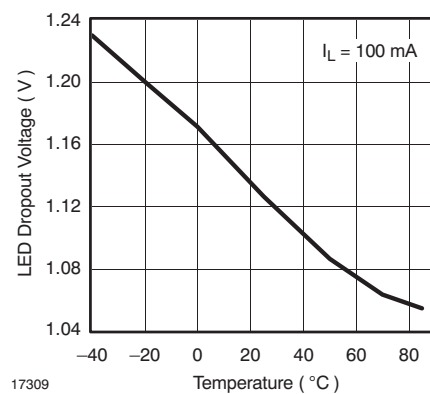
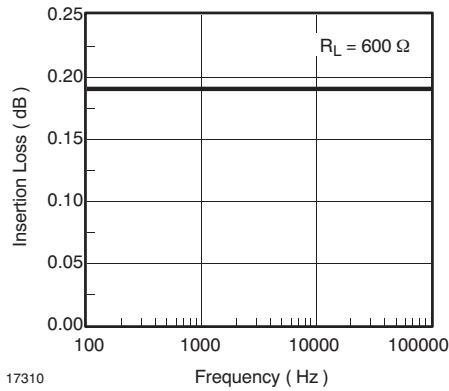
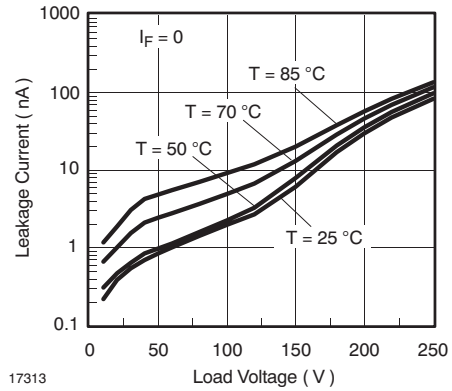

Figure 10. LED Dropout Voltage vs. Temperature



17310

Figure 11. Insertion Loss vs. Frequency



17313

Figure 14. Leakage Current vs. Applied Voltage

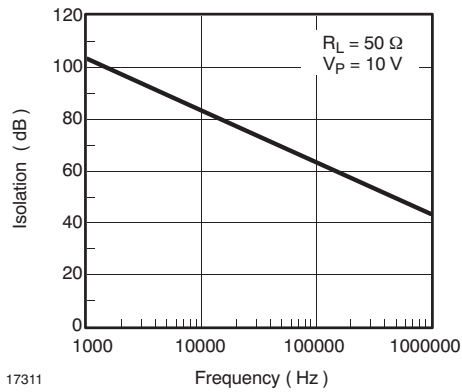

17311

Figure 12. Output Isolation

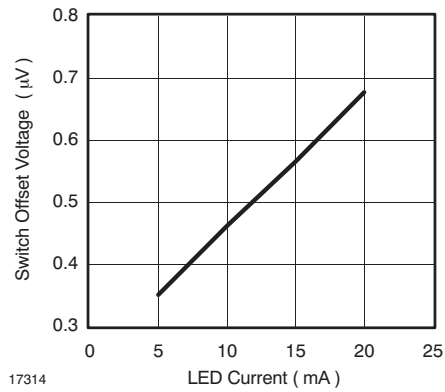

17314

Figure 15. Switch Offset Voltage vs. LED Current

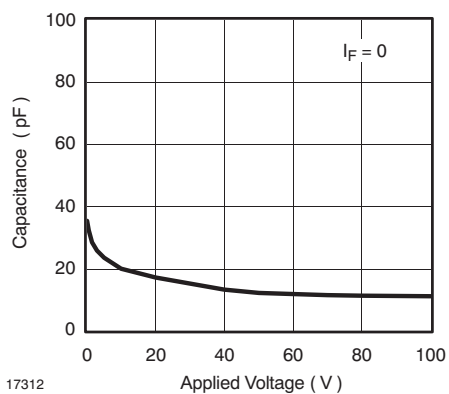

17312

Figure 13. Switch Capacitance vs. Applied Voltage

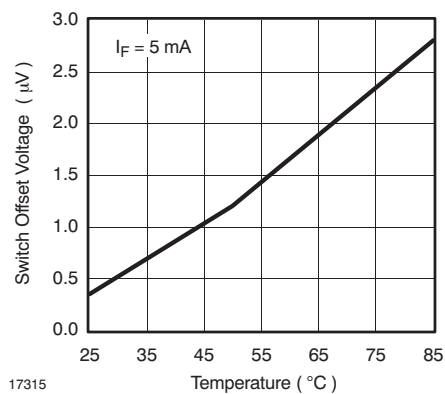

17315

Figure 16. Switch Offset Voltage vs. Temperature

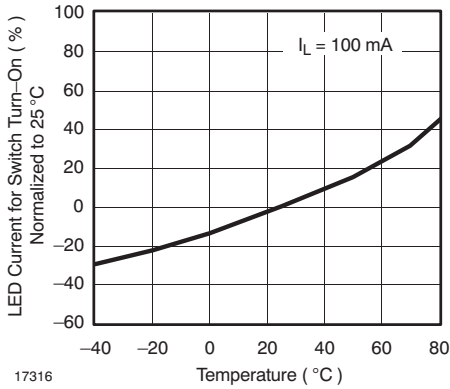

Figure 17. LED Current for Switch Turn-on vs. Temperature

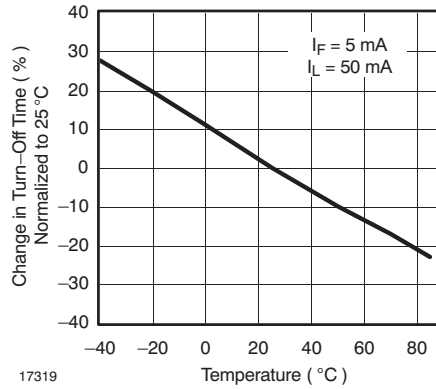

Figure 20. Turn-off Time vs. Temperature

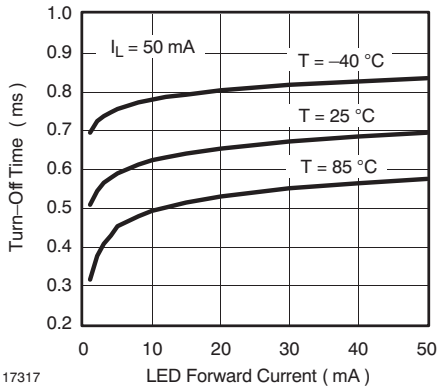

Figure 18. Turn-off Time vs. LED Current

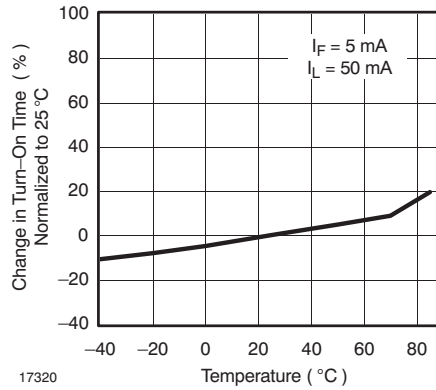

Figure 21. Turn-on Time vs. Temperature

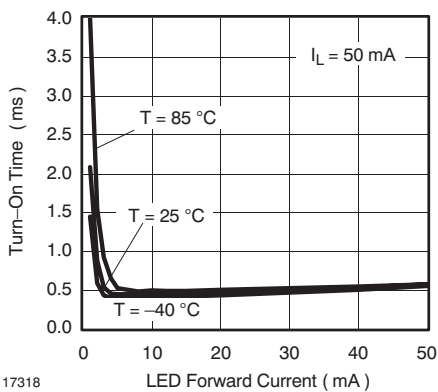
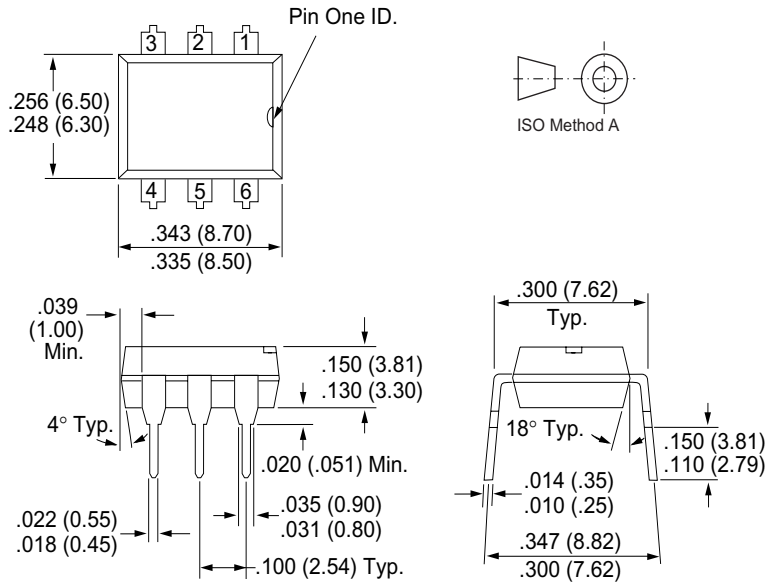

Figure 19. Turn-on Time vs. LED Current

Package Dimensions in Inches (mm)

DIP



Package Dimensions in Inches (mm)

SMD

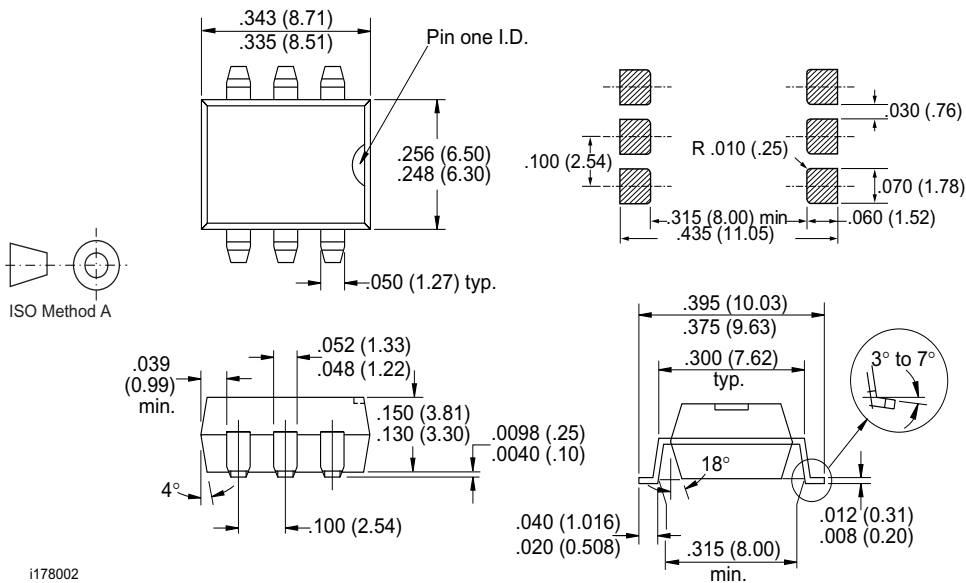

Ozone Depleting Substances Policy Statement

It is the policy of Vishay Semiconductor GmbH to

1. Meet all present and future national and international statutory requirements.
2. Regularly and continuously improve the performance of our products, processes, distribution and operating systems with respect to their impact on the health and safety of our employees and the public, as well as their impact on the environment.

It is particular concern to control or eliminate releases of those substances into the atmosphere which are known as ozone depleting substances (ODSs).

The Montreal Protocol (1987) and its London Amendments (1990) intend to severely restrict the use of ODSs and forbid their use within the next ten years. Various national and international initiatives are pressing for an earlier ban on these substances.

Vishay Semiconductor GmbH has been able to use its policy of continuous improvements to eliminate the use of ODSs listed in the following documents.

1. Annex A, B and list of transitional substances of the Montreal Protocol and the London Amendments respectively
2. Class I and II ozone depleting substances in the Clean Air Act Amendments of 1990 by the Environmental Protection Agency (EPA) in the USA
3. Council Decision 88/540/EEC and 91/690/EEC Annex A, B and C (transitional substances) respectively.

Vishay Semiconductor GmbH can certify that our semiconductors are not manufactured with ozone depleting substances and do not contain such substances.

We reserve the right to make changes to improve technical design
and may do so without further notice.

Parameters can vary in different applications. All operating parameters must be validated for each customer application by the customer. Should the buyer use Vishay Semiconductors products for any unintended or unauthorized application, the buyer shall indemnify Vishay Semiconductors against all claims, costs, damages, and expenses, arising out of, directly or indirectly, any claim of personal damage, injury or death associated with such unintended or unauthorized use.

Vishay Semiconductor GmbH, P.O.B. 3535, D-74025 Heilbronn, Germany
Telephone: 49 (0)7131 67 2831, Fax number: 49 (0)7131 67 2423